

# ZÁKLADNÍ ŠKOLA TGM V OTROKOVICÍCH

**Revitalizace chodbových prostor**

KONCEPT

01 KONCEPT

02 SITUAČNÍ VÝKRES

03 PŘEHLEDOVÝ PLÁN

04 NOVÁ SITUACE

05 ZÓNY

06 SCHÉMATA

07 JEDNOTLIVÉ PROSTORY

○ pravá část - druhý stupeň

□ střed - hlavní prostor

△ levá část - první stupeň

08 MOODBOARD

## OSNOVA

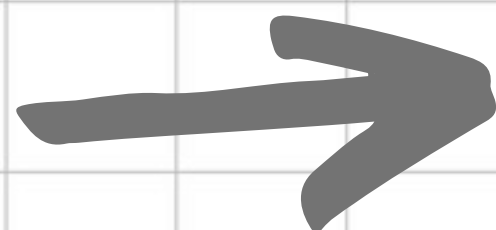

VYTVOŘIT JEDNU IDENTITU

\* ŠKOLA CO CHRÁNÍ ŽIVOTNÍ PROSTŘEDÍ

**CÍLE PROJEKTU**



EKOLOGIE



INKLUZIVITA

DVĚ HLAVNÍ TÉMATA



- \*Edukační prvky**
- \*Udržitelné materiály**
- \*Teorie barev**
- \*Dětská psychologie**

DALŠÍ TÉMATA

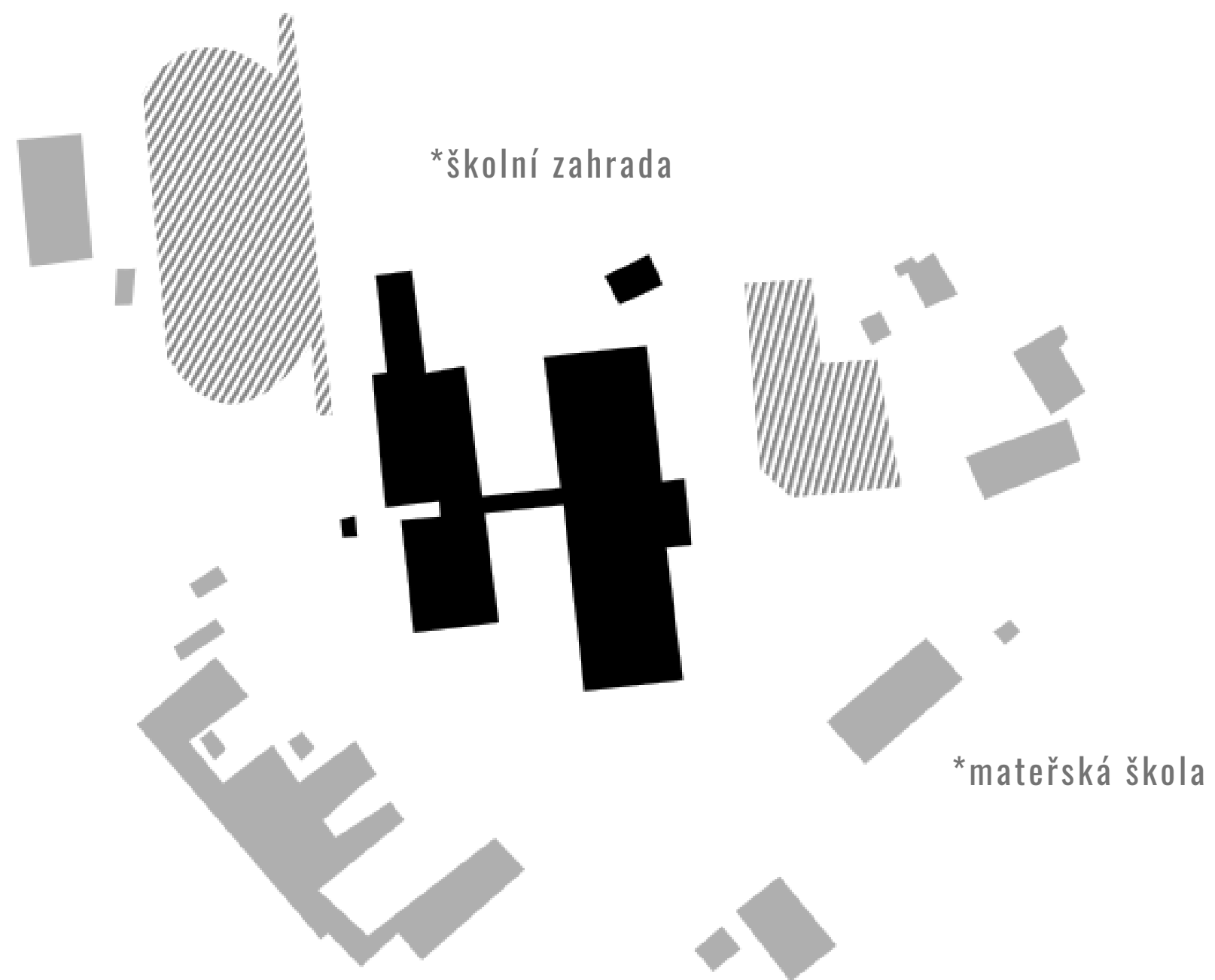

20

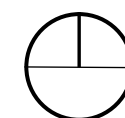

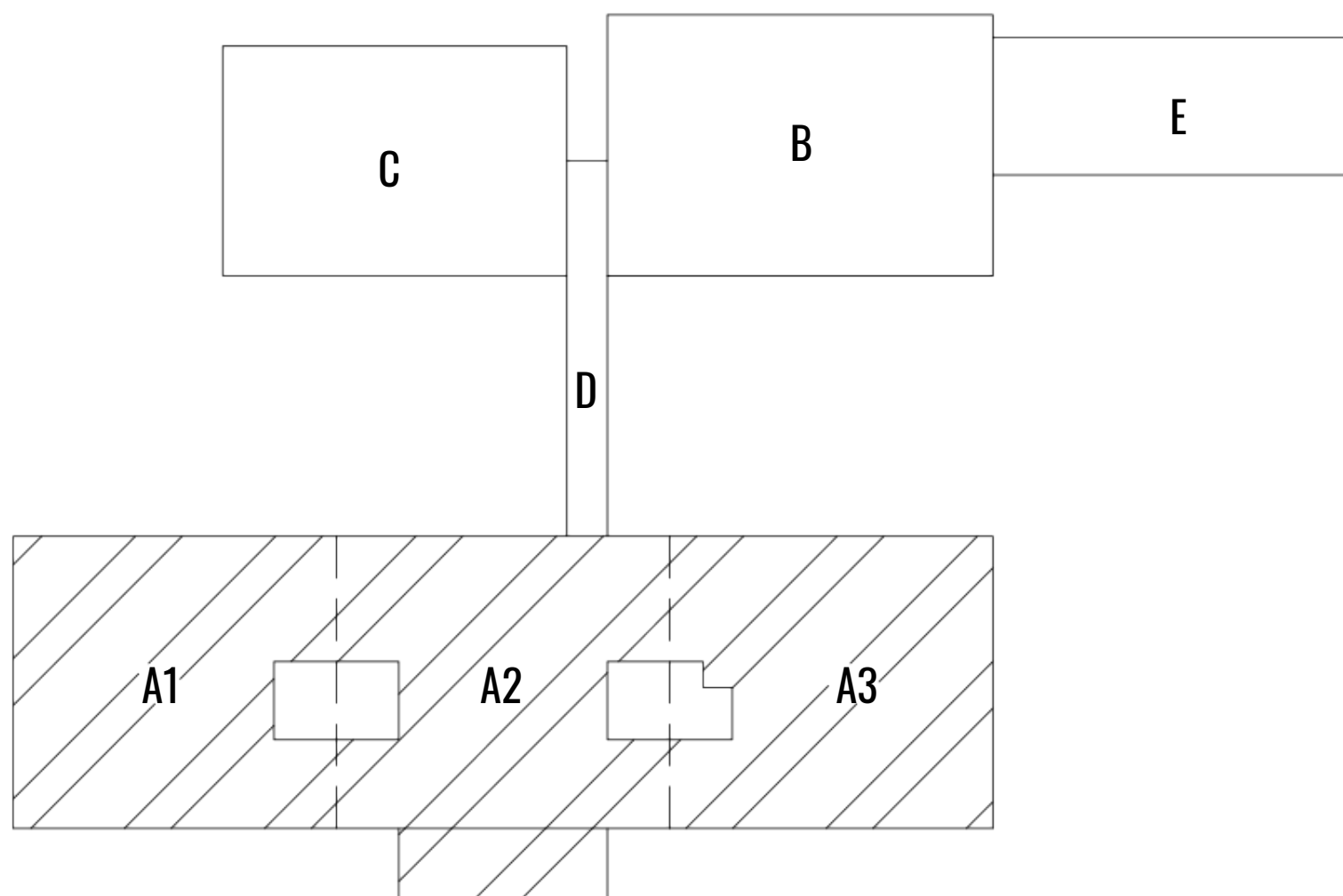

////// rešené části

\*přehledový plán

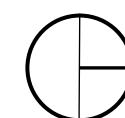

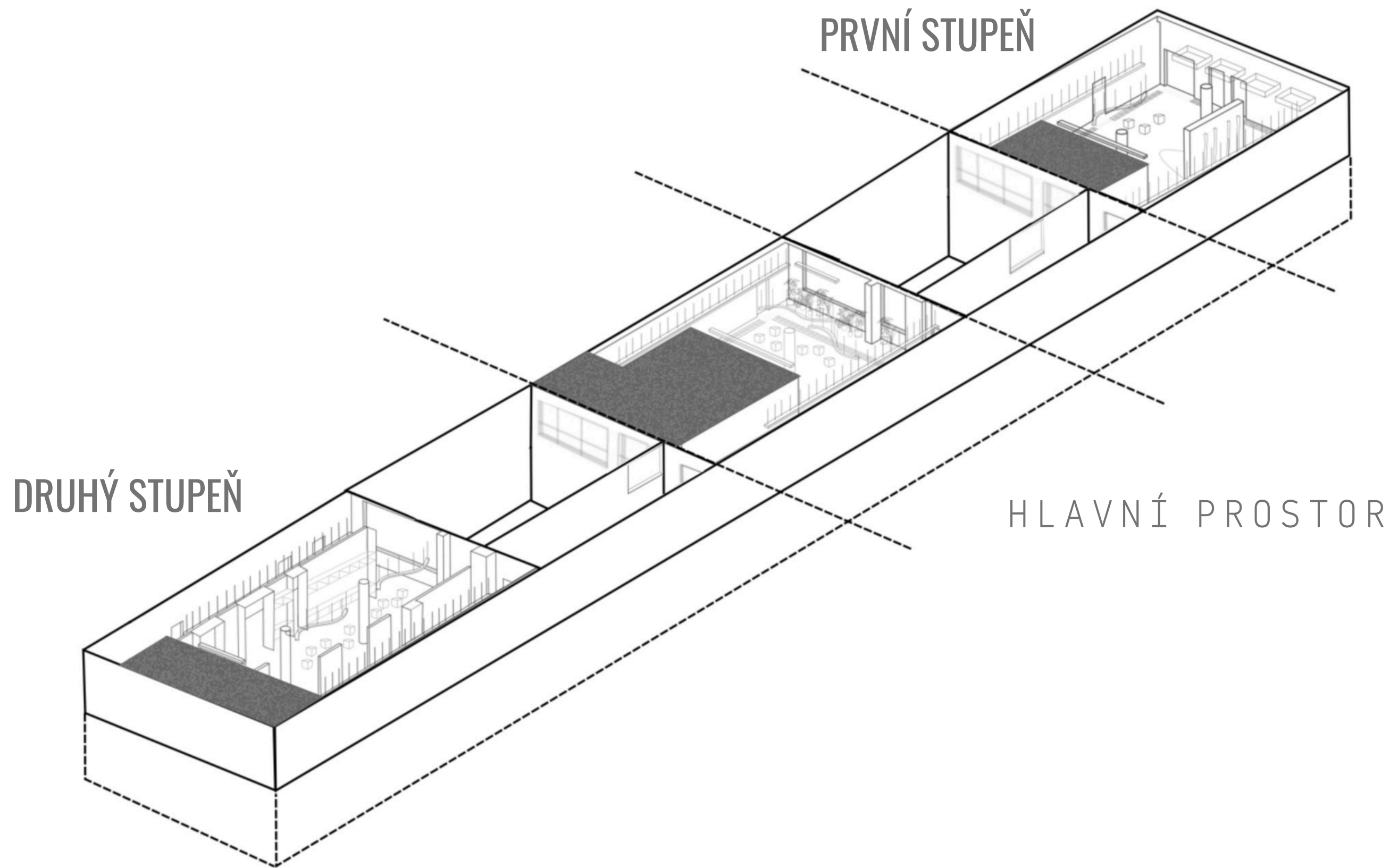

FLUM060-S

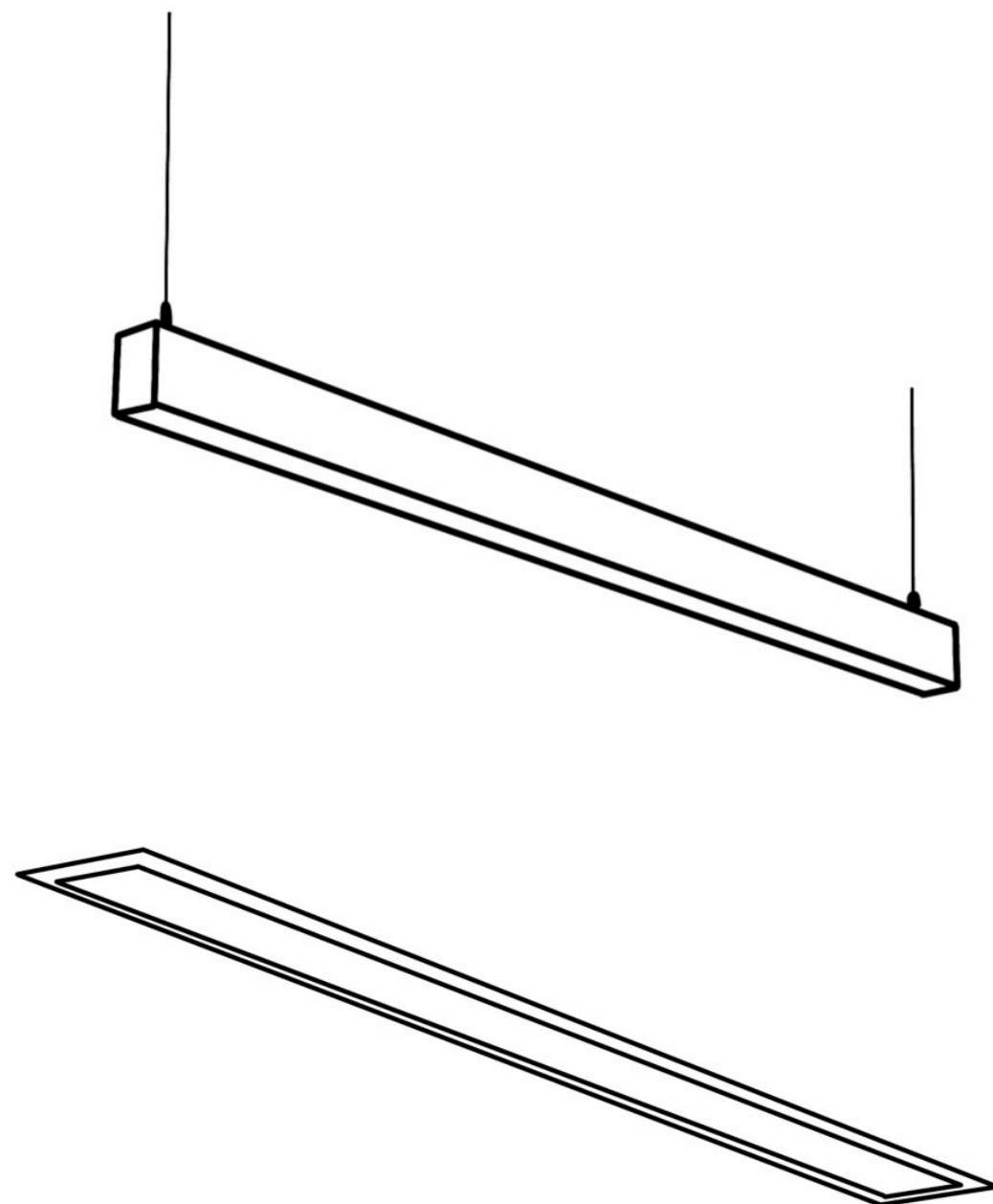

FLUM060-S

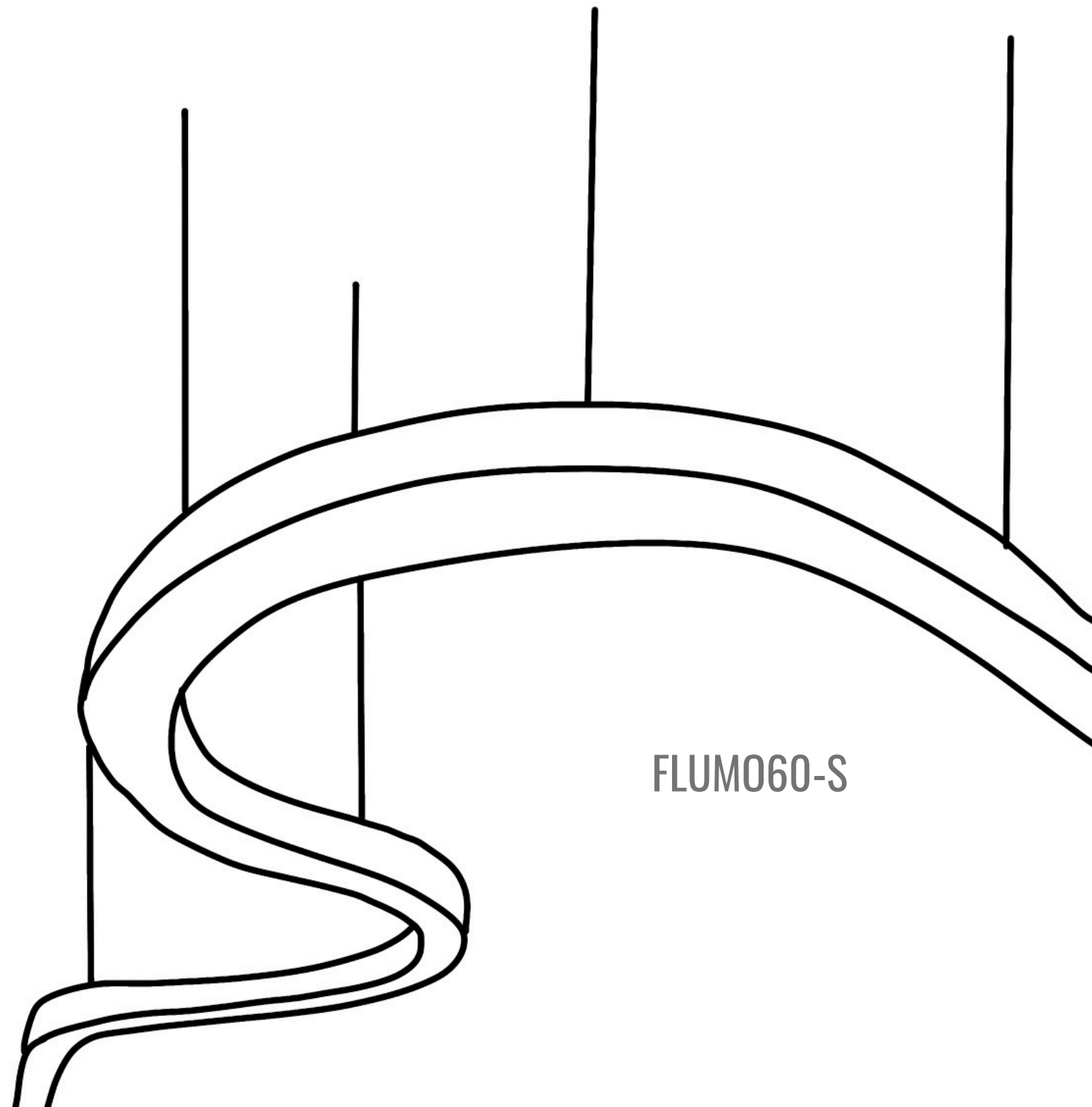

\* f i r m a H A L L A

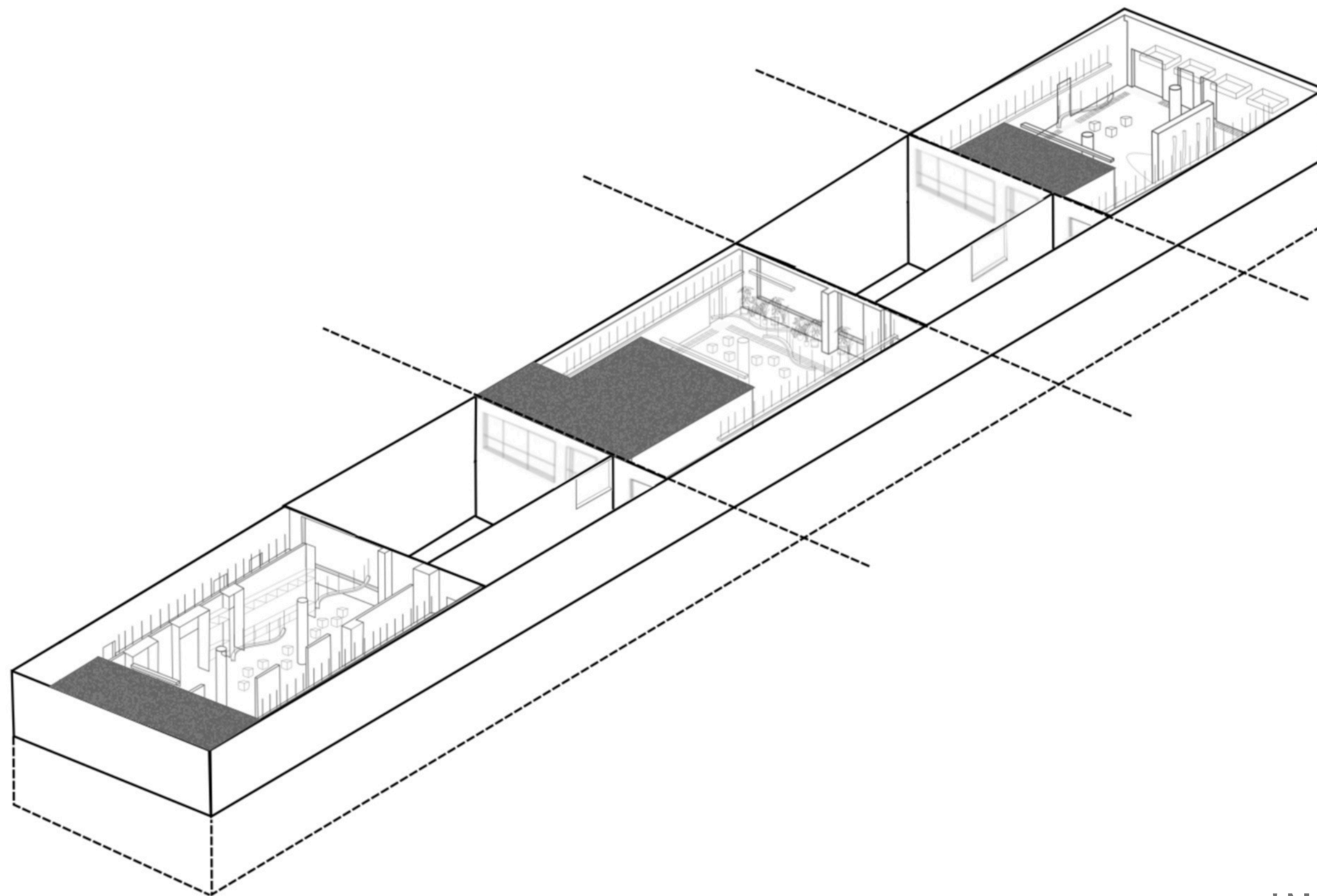

\*NOVÝ STAV

## GRAFICKÉ SCHÉMATA

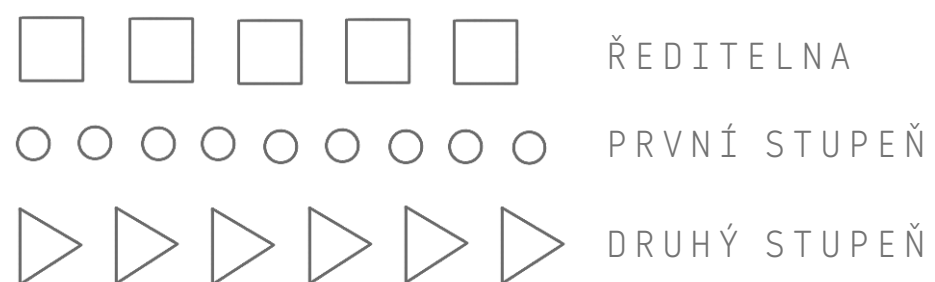

## TAKTICKÉ PRVKY

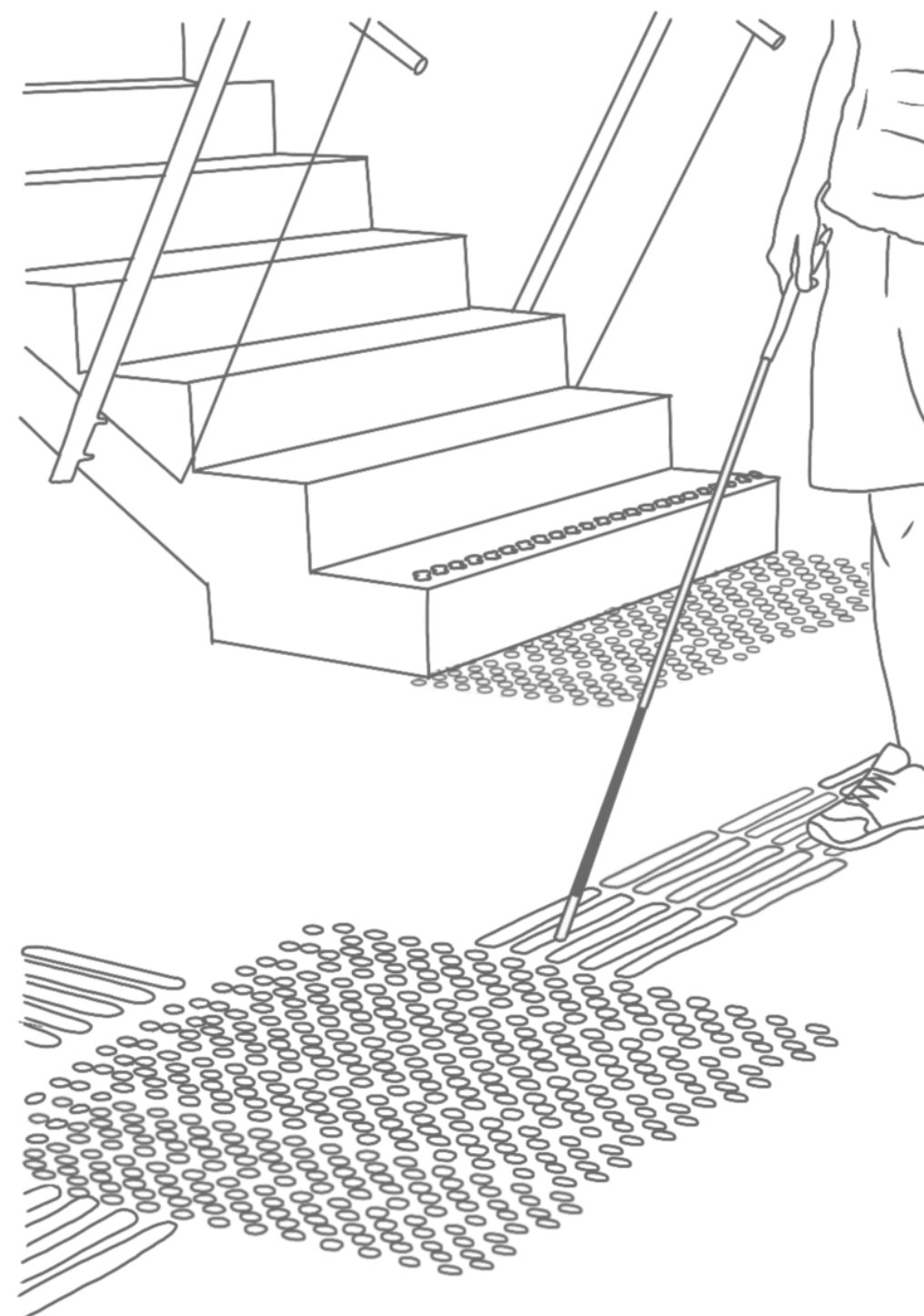
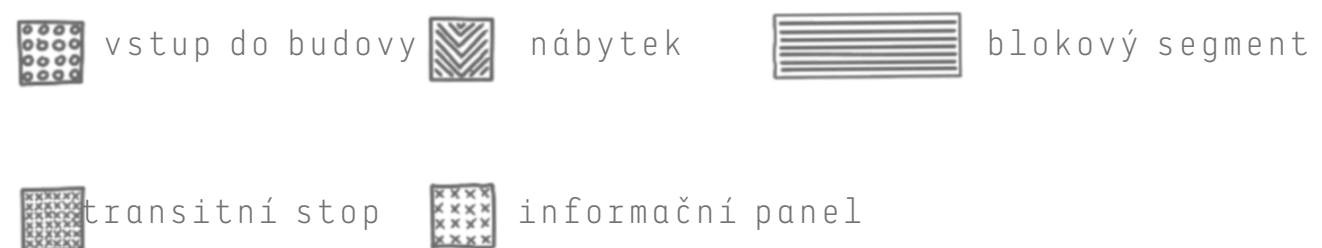



druhý stupeň ►  
● první stupeň





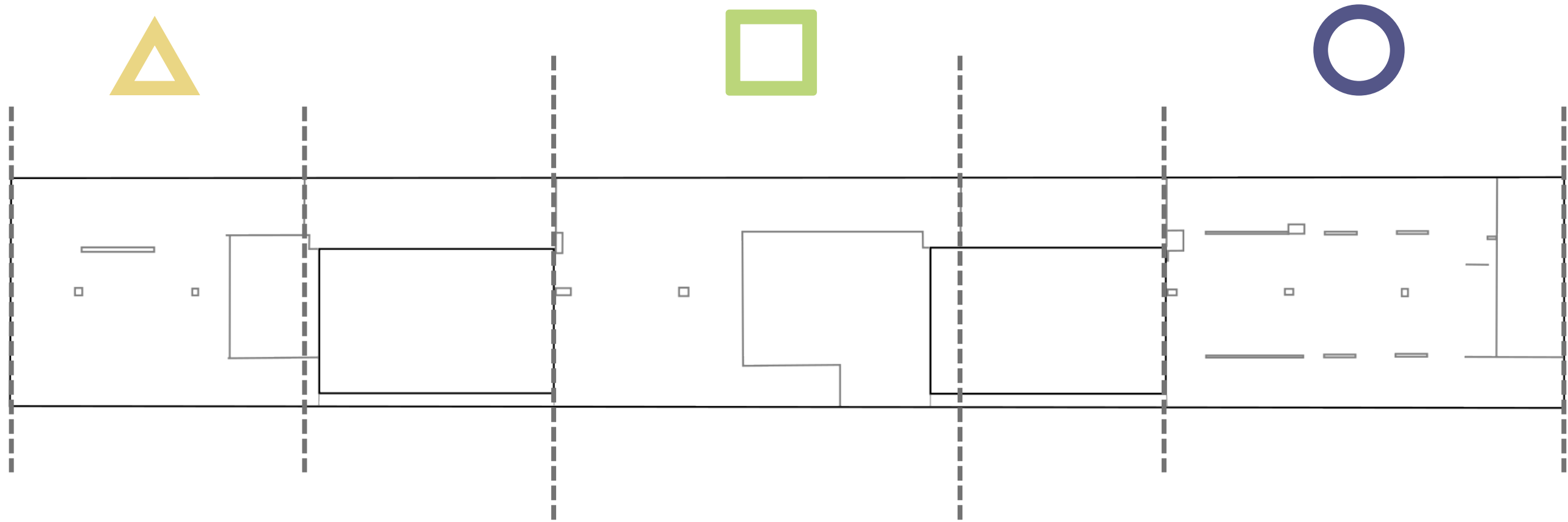

PRVNÍ STUPEŇ

HLAVNÍ PROSTOR

DRUHÝ STUPEŇ

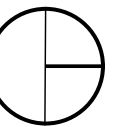

KLIDNÁ ZÓNA

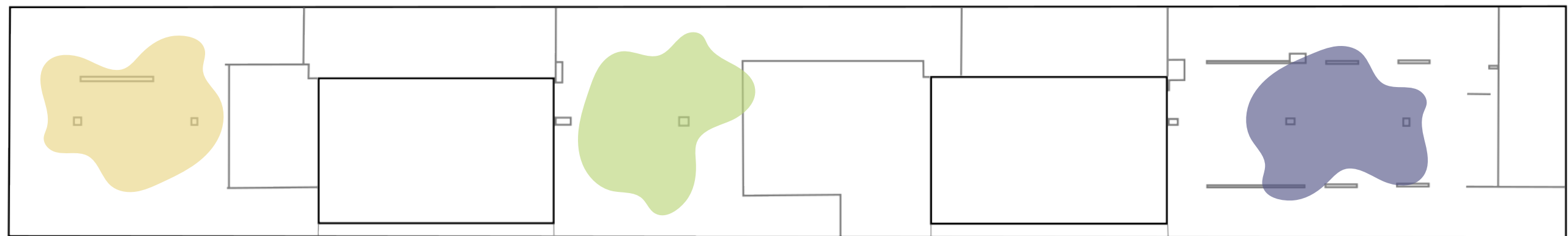

AKTIVNÍ HRACÍ ZÓNA

ÚLOŽNÝ PROSTOR

AKTIVITY

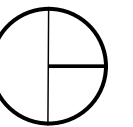

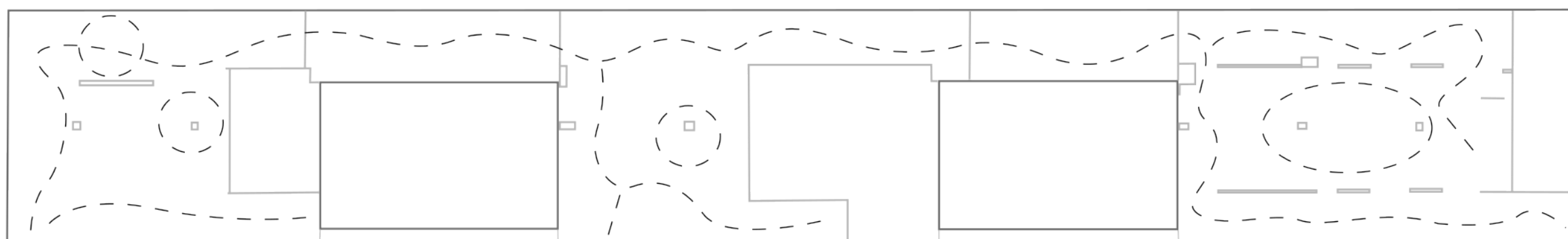

# ПОHYB

----- trasa

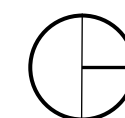

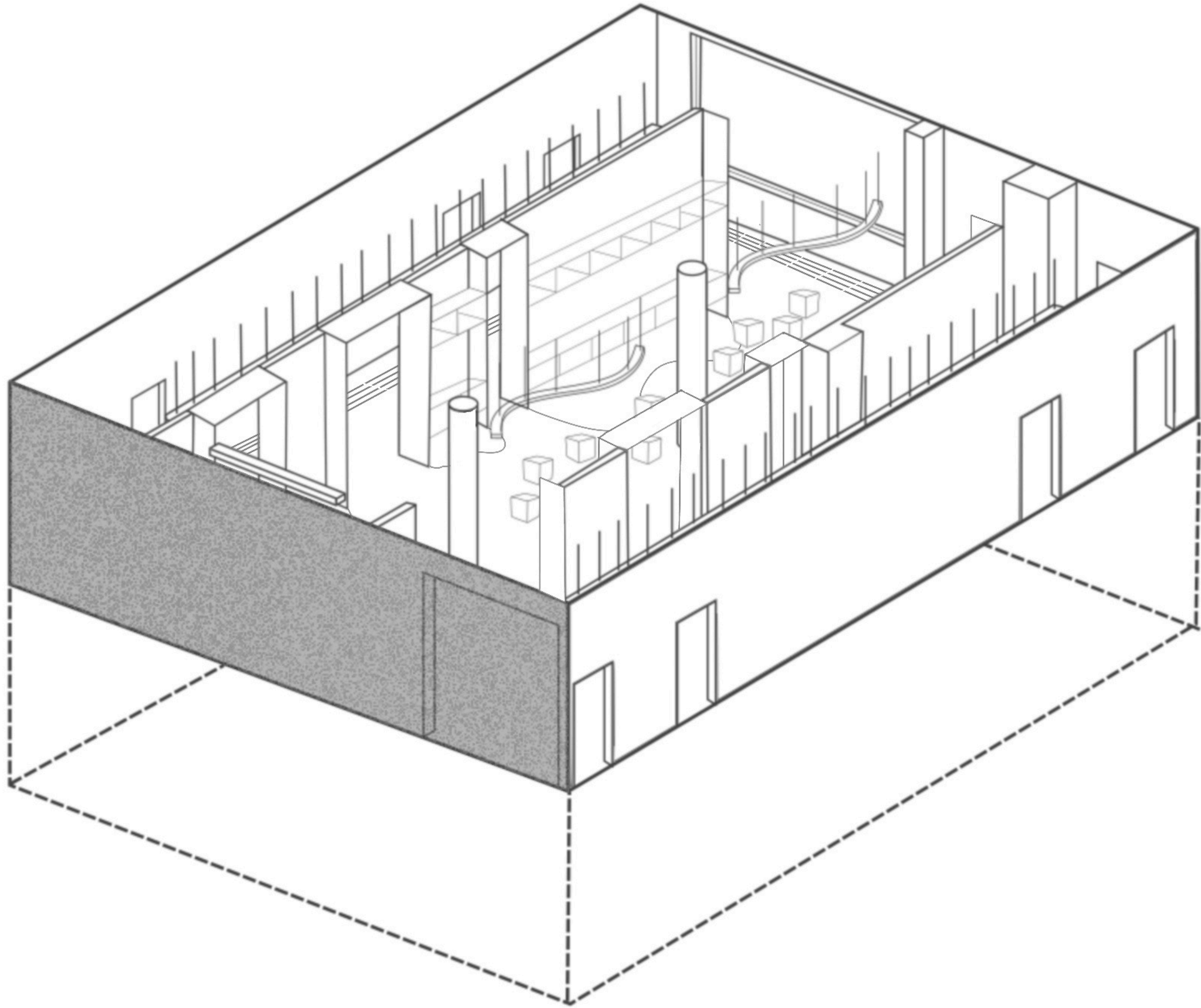



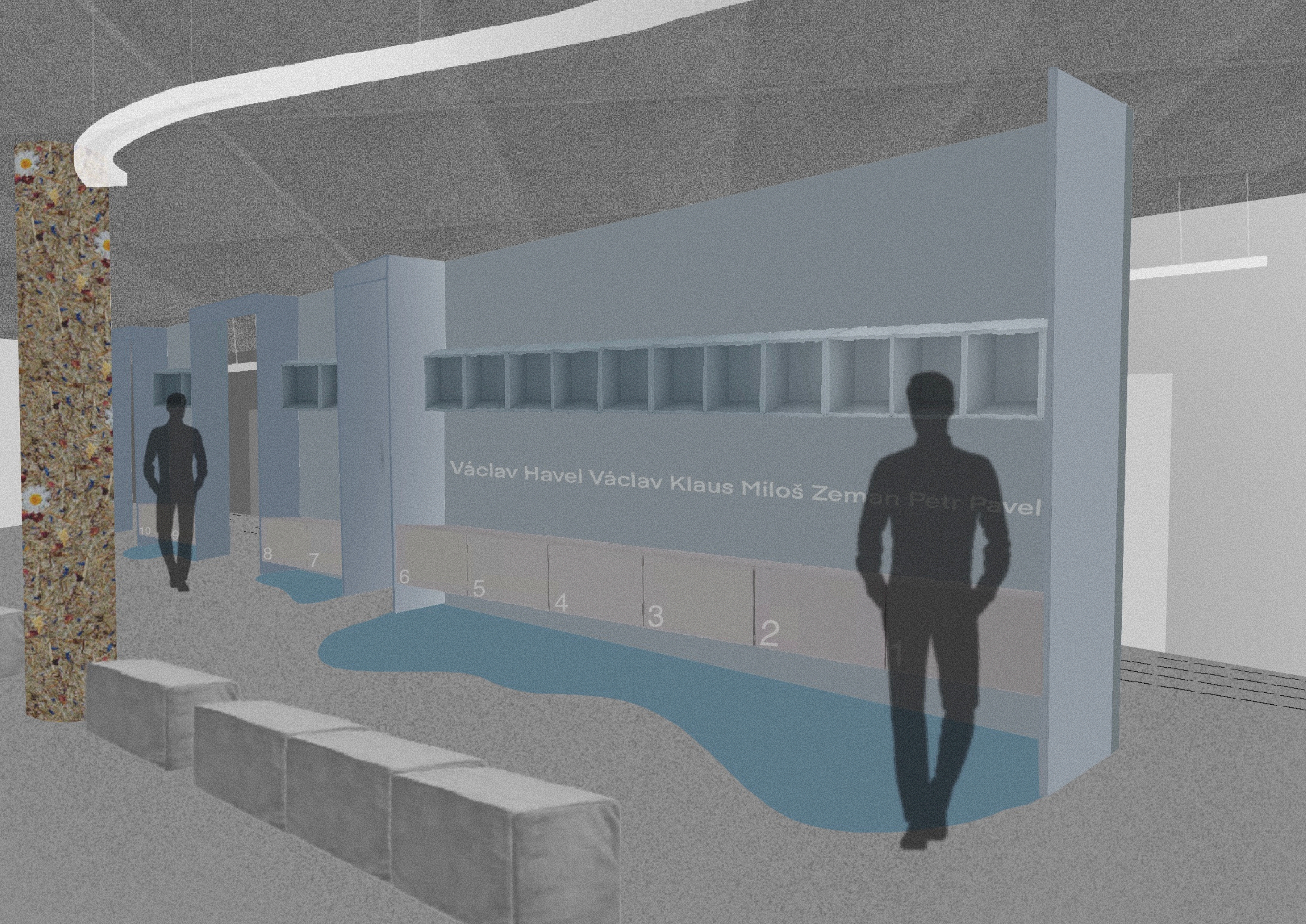

Václav Havel Václav Klaus Miloš Zeman Petr Pávek

10 9

8 7

6

5

4

3

2



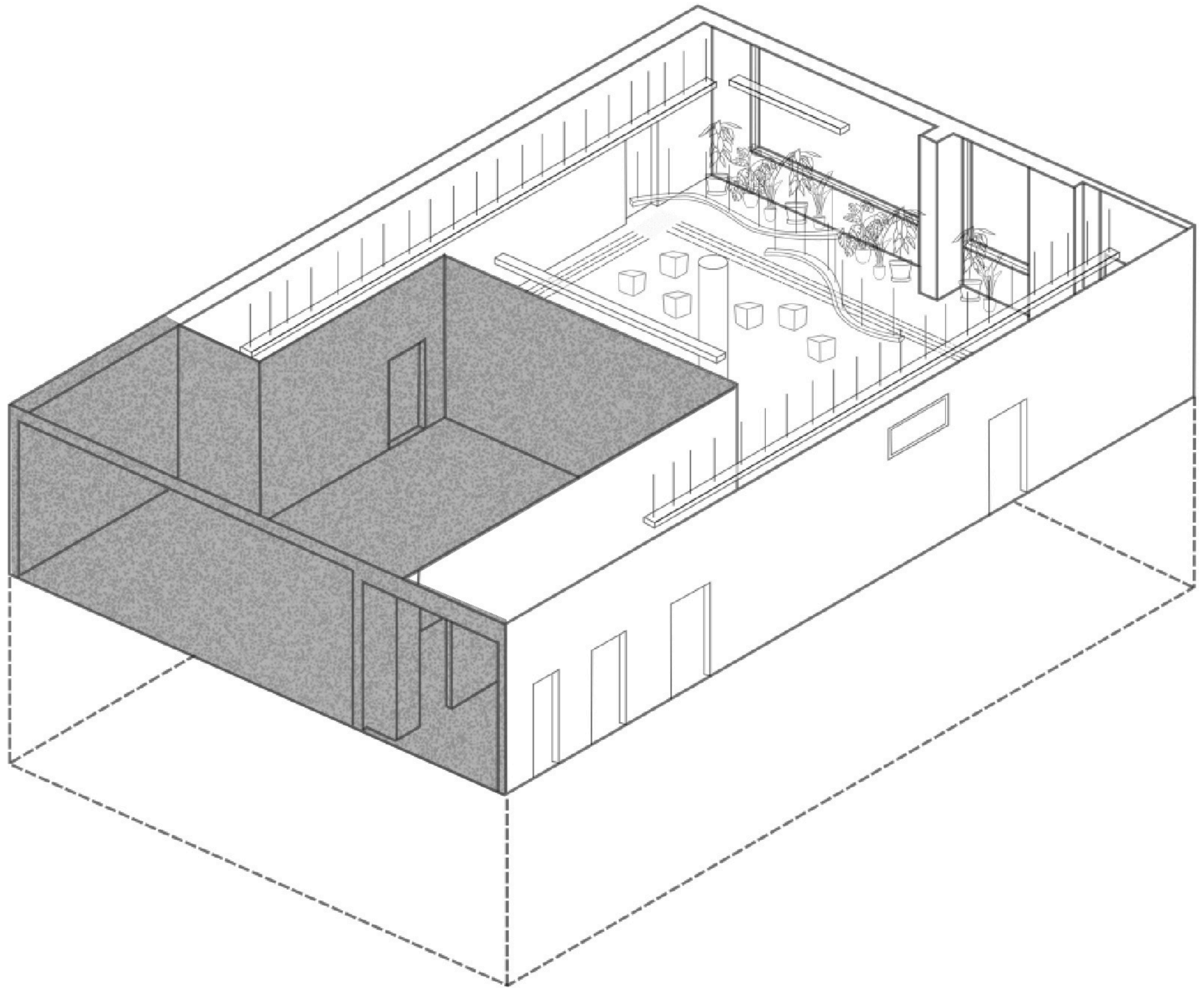



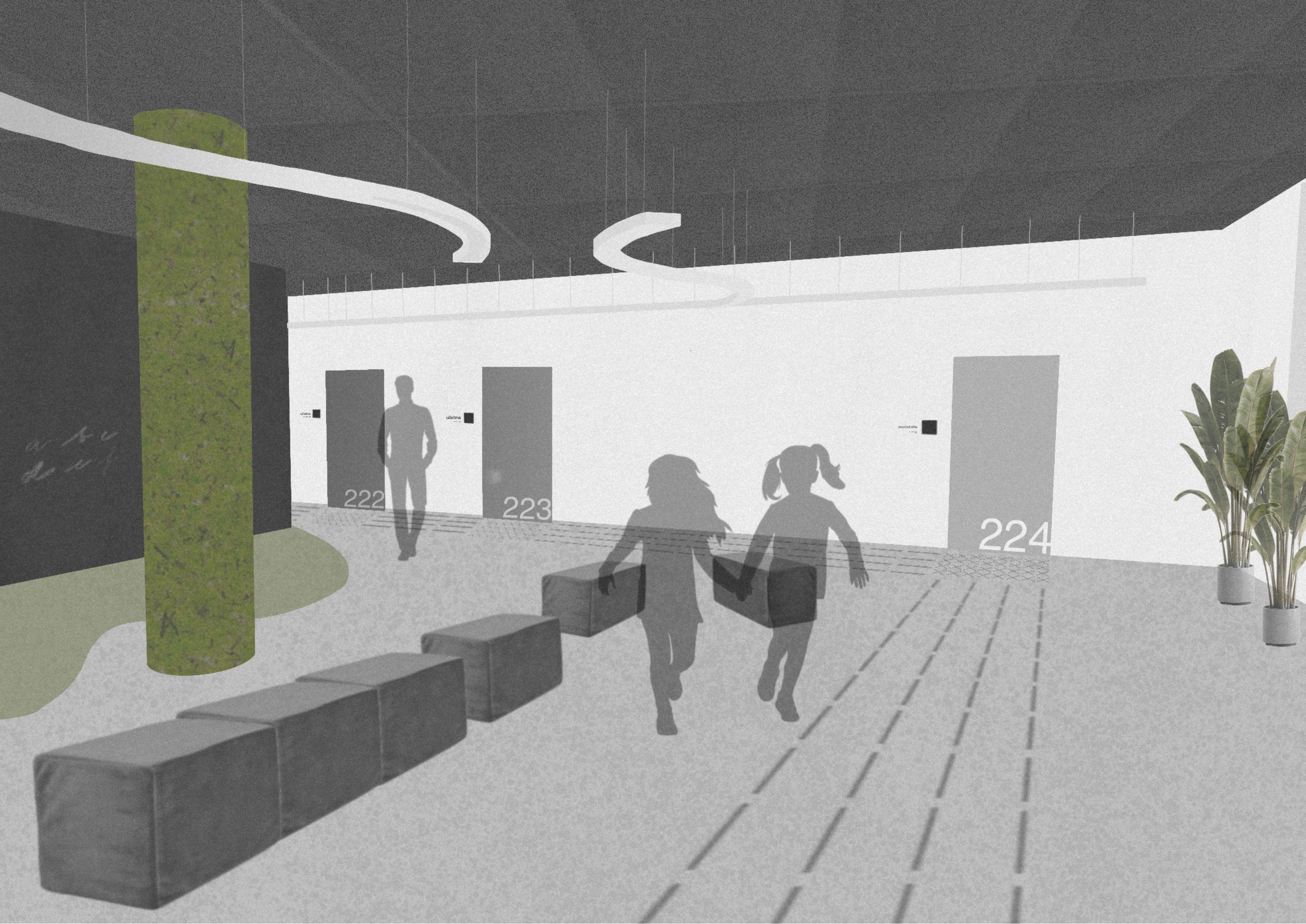



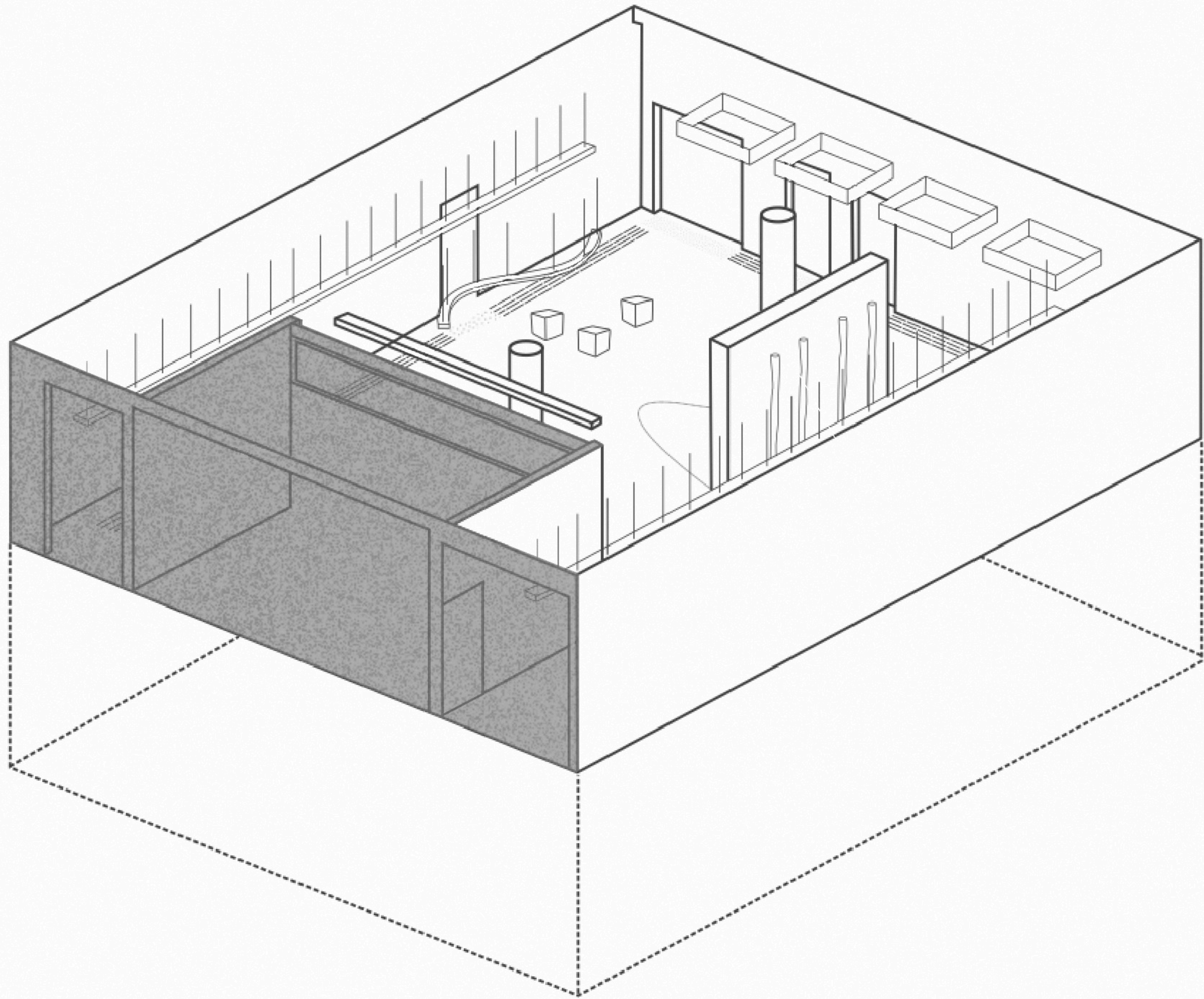



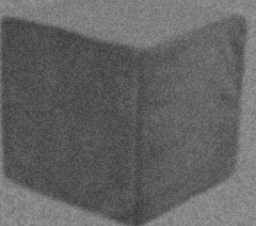
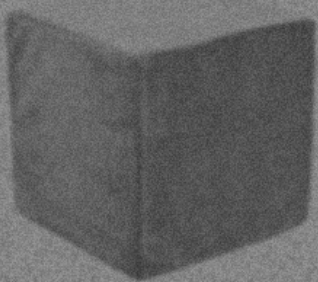
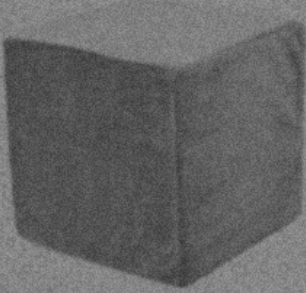
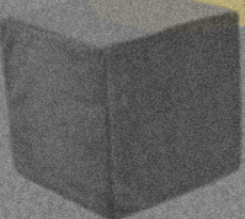
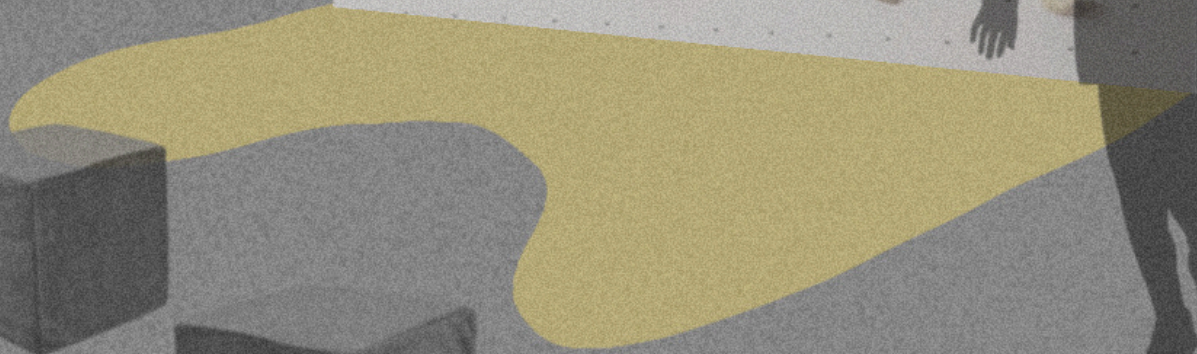
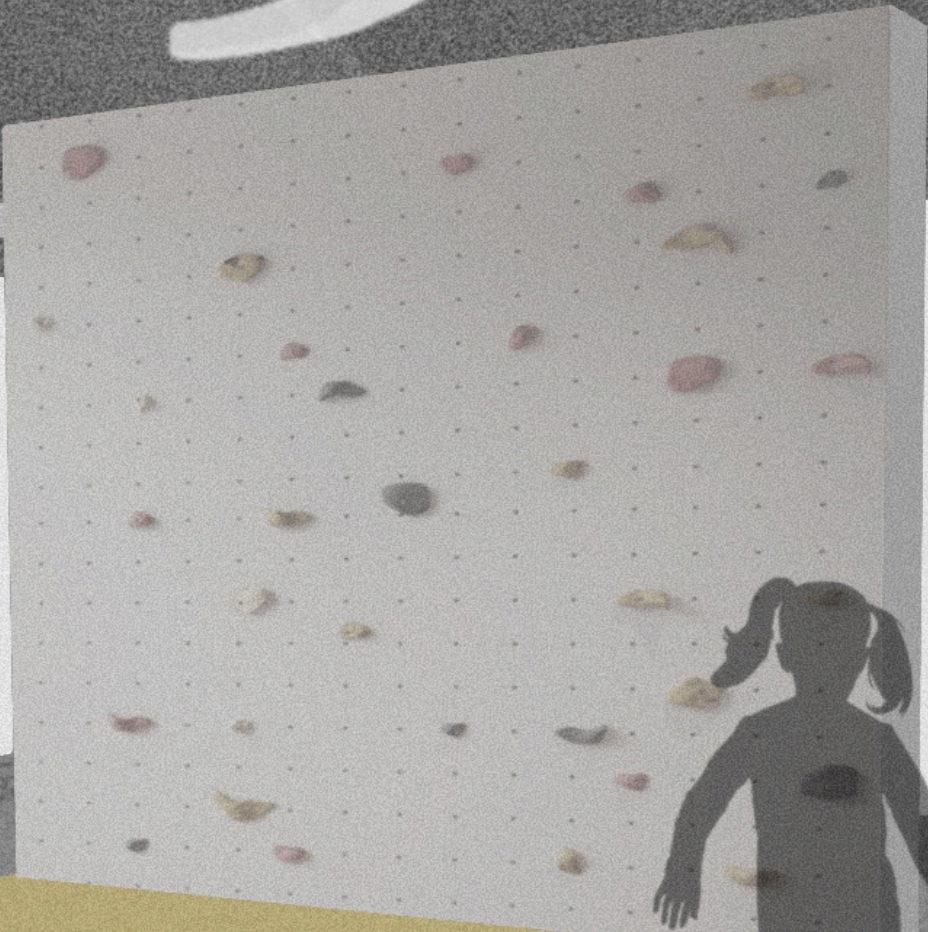

ABC

237

+ scitari  
- odecitari

LA  
HA 1.3.5.7.9.11  
DA 2.4.6.8.10.12





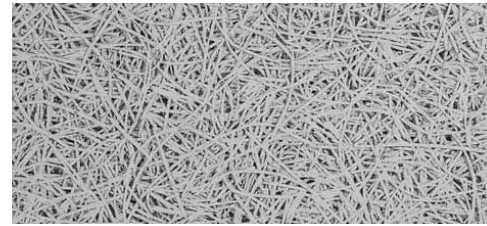
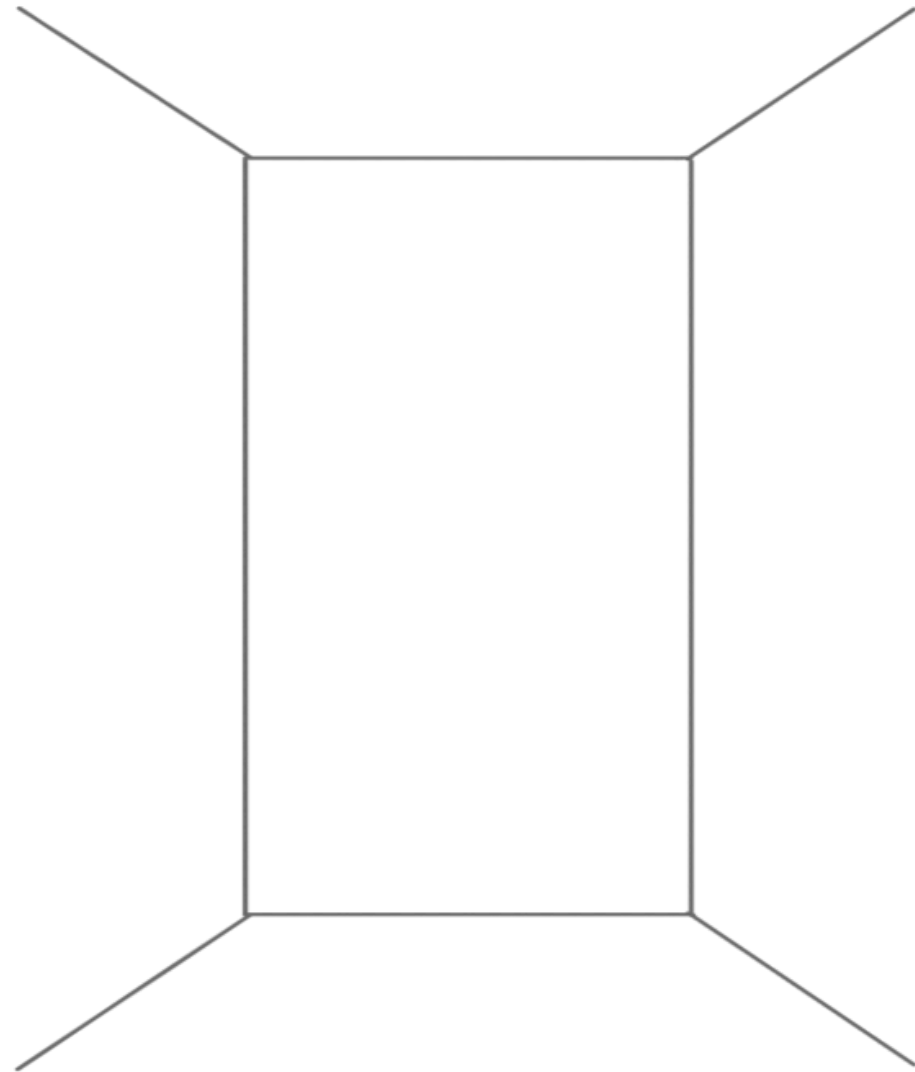

HERAKLIT



BETONOVÁ STĚRKA

**\*citáty, edukační nápisy**

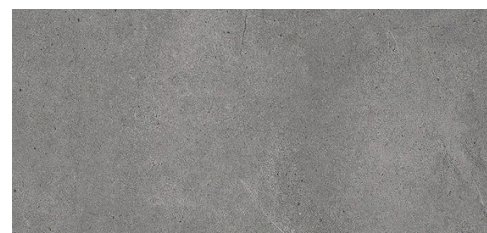

VINYL + EPOXIDOVÉ NÁTĚRY

**\*taktické prvky**

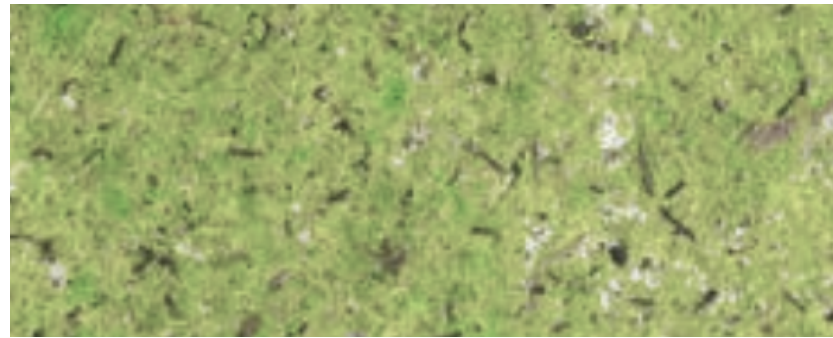
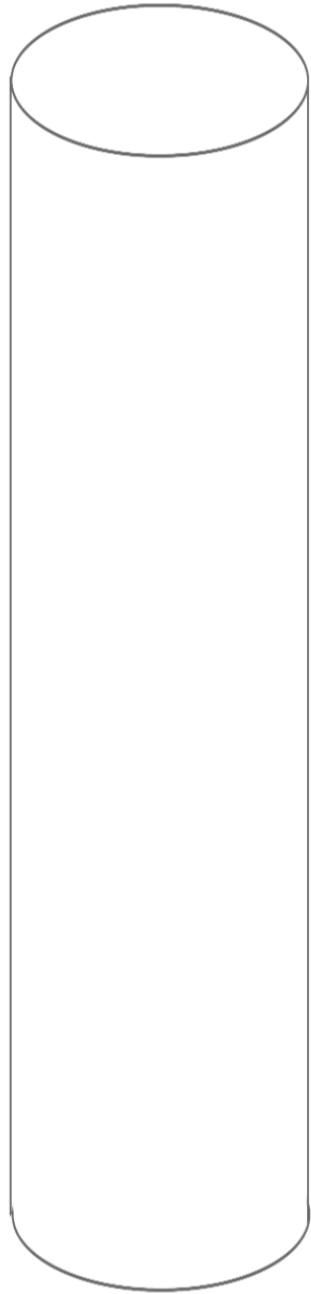

PŘÍRODNÍ FOLIE

\*Avery Dennison

# SUMARIZACE

\* V Y T V O Ř E N Í I D E N T I T Y

sjednocení pomocí grafických schémat a barevnosti

\* E K O L O G I E

materiály, edukační prvky

\* I N K L U Z I V I T A

taktické prvky

# CO DÁL

\* Dotazník

\* Návaznost na školní zahradu

**děkuji za pozornost.**



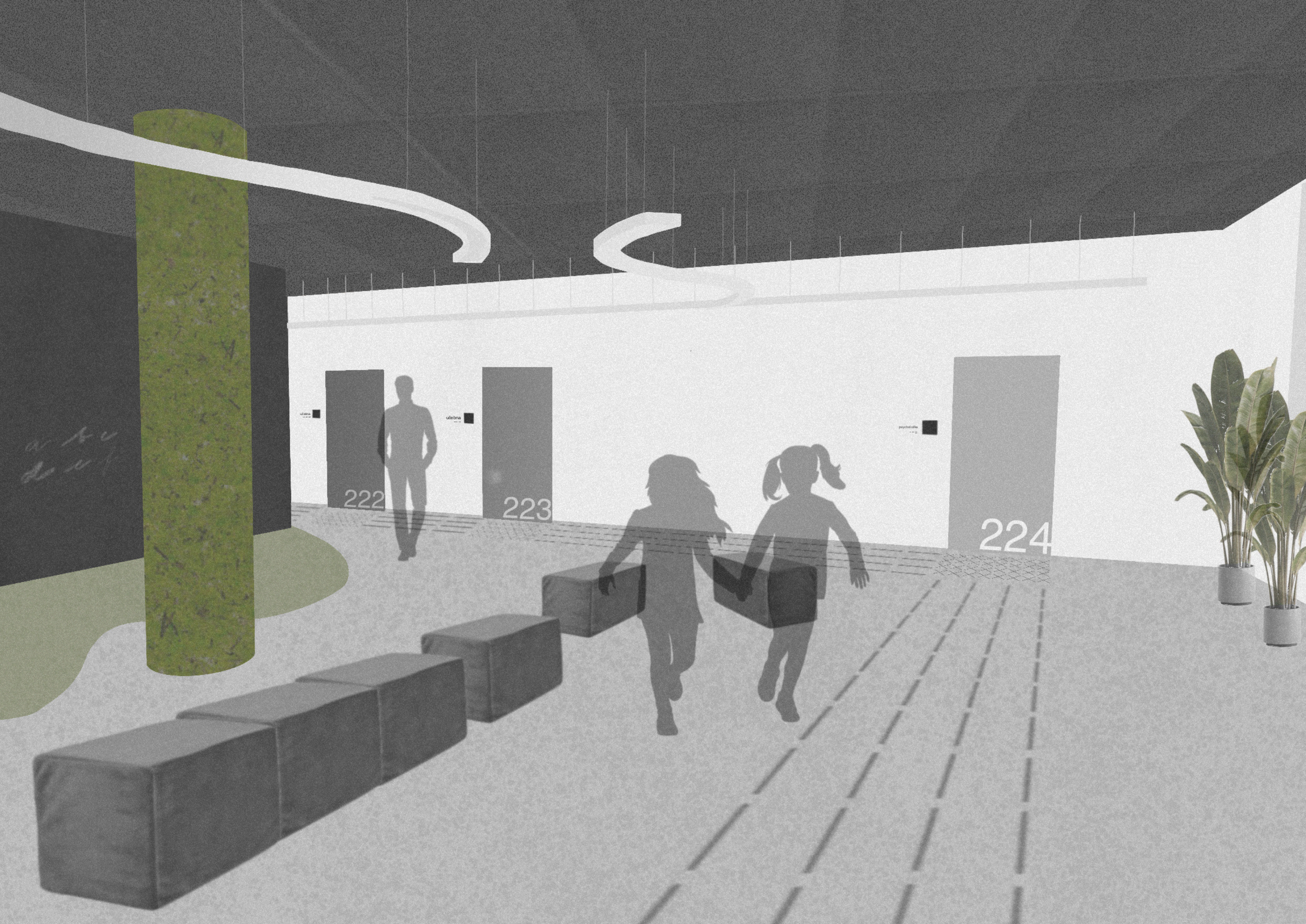

222

223

224

222

223

224